

# ALTAÏR COB

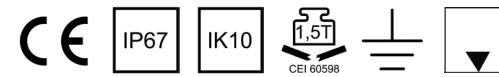

Encastré de sol à COB

COB Ground recessed luminaire

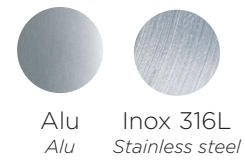
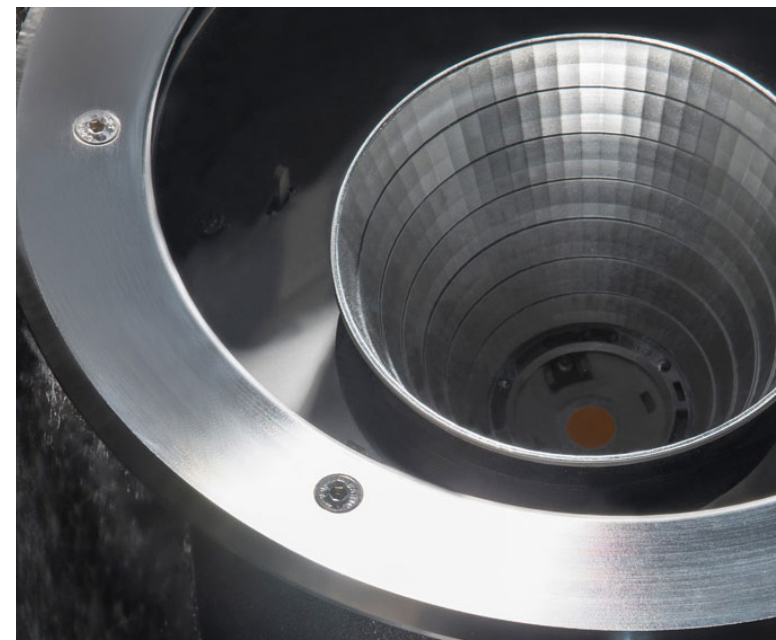
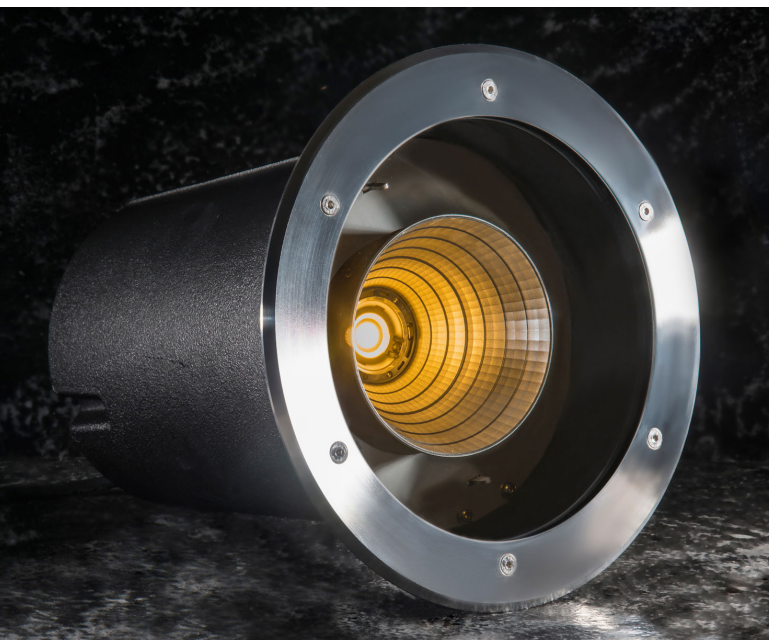

|  | BASSE PUISSANCE<br><i>Low power</i>        | HAUTE PUISSANCE<br><i>High power</i>         |
|--|--|--|
| Source / Source                          | 1 LED 3-SDCM - L90B10@50.000hr             |  |
| T° de couleur / Color T°                 | Monochrome                                 |  |
| Flux produit / Product flux <sup>1</sup> | 2950lm                                     | 6850lm                                       |
| Efficacité / Efficacy                    | - 100lm/W                                  | - 107lm/W                                    |
| Optique / Optic                          | 7° / 14° / 32° / 73°                       | 15° / 21° / 38° / 71°                        |
| Orientable / Adjustable                  | Non / No                                   |  |
| Puissance / Power                        | 30W_max                                    | 67W_max                                      |
| Alimentation / Power supply              | 230VAC                                     |  |
| Classe énergie / Energy class            | E  | E  |
| Pilotage / Control <sup>2</sup>          | On-Off / 1-10V / DALI (Déporté / Remote)   |  |
| Câblage / Cables <sup>3</sup>            | 1ml standard - 3x1mm <sup>2</sup> noir     |  |
| Disque / Disk                            | Rond Arrasant (1)<br><i>Trimless round</i> | Rond Recouvrant (2)<br><i>Covering round</i> |
| (A) Dimension disque / Disk size         | Ø260mm                                     | Ø280mm                                       |
| Options / Options                        |  |  |

<sup>1</sup> 3000K-7°/15° en sortie produit / 3000K-7°/15° at product output

<sup>2</sup> A commander séparément selon driver / To order separately with adequate driver

<sup>3</sup> Certifié usage extérieur / Certified for outdoor use

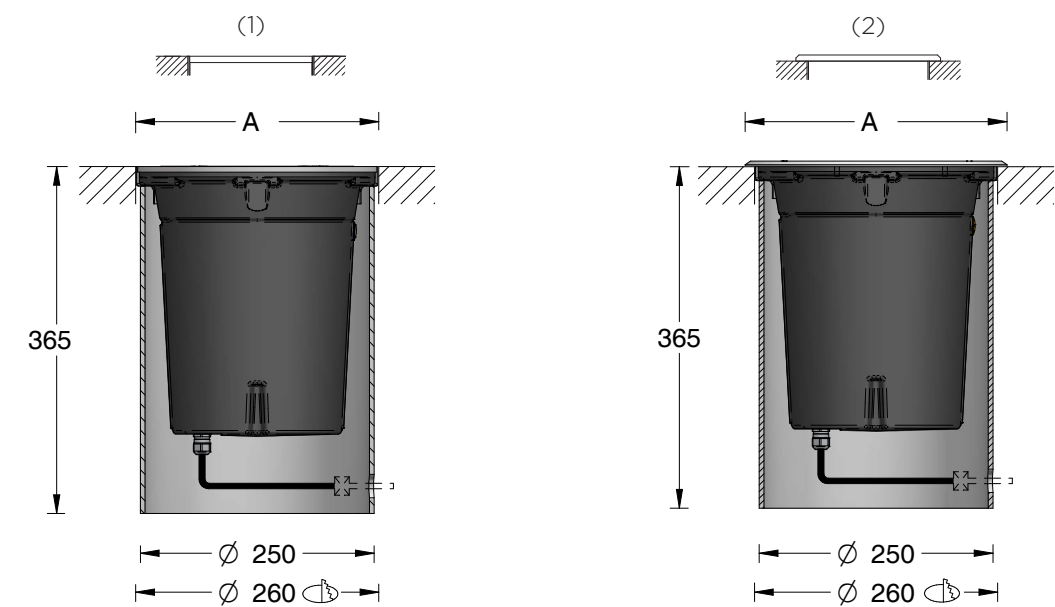

- Le plus puissant des encastrés de la gamme / The most powerful recessed luminaire in the range
- Alimentation intégrée / Power supply Integrated



# ALTAÏR COB





ALUMINIUM / Aluminium  BASSE PUISSANCE / Low Power

| T° couleur<br>Color T° | Optique<br>Optic | Flux*<br>Flux* | Puissance**<br>Power** | 230VAC                        |
|------------------------|------------------|----------------|------------------------|-------------------------------|
| 2700K                  | VNSP (7°)        | 2821lm         | 30W                    | <a href="#">E21.216.003.0</a> |
| 2700K                  | NSP (14°)        | 2611lm         | 30W                    | <a href="#">E21.216.002.0</a> |
| 2700K                  | FL (32°)         | 2551lm         | 30W                    | <a href="#">E21.416.001.0</a> |
| 2700K                  | VWFL (73°)       | 2731lm         | 30W                    | <a href="#">E21.616.001.0</a> |
| 3000K                  | VNSP (7°)        | 2950lm         | 30W                    | <a href="#">E21.216.000.0</a> |
| 3000K                  | NSP (14°)        | 2726lm         | 30W                    | <a href="#">E21.216.001.0</a> |
| 3000K                  | FL (32°)         | 2663lm         | 30W                    | <a href="#">E21.416.000.0</a> |
| 3000K                  | VWFL (73°)       | 2851lm         | 30W                    | <a href="#">E21.616.000.0</a> |
| 4000K                  | VNSP (7°)        | 3117lm         | 30W                    | <a href="#">E21.226.000.0</a> |
| 4000K                  | NSP (14°)        | 2885lm         | 30W                    | <a href="#">E21.226.001.0</a> |
| 4000K                  | FL (32°)         | 2819lm         | 30W                    | <a href="#">E21.426.000.0</a> |
| 4000K                  | VWFL (73°)       | 3018lm         | 30W                    | <a href="#">E21.626.000.0</a> |

ALUMINIUM / Aluminium  HAUTE PUISSANCE / High power

| T° couleur<br>Color T° | Optique<br>Optic | Flux*<br>Flux* | Puissance**<br>Power** | 230VAC                        |
|------------------------|------------------|----------------|------------------------|-------------------------------|
| 2700K                  | NSP (15°)        | 6552lm         | 67W                    | <a href="#">E21.218.001.0</a> |
| 2700K                  | SP (21°)         | 6184lm         | 67W                    | <a href="#">E21.318.001.0</a> |
| 2700K                  | FL (38°)         | 6111lm         | 67W                    | <a href="#">E21.418.001.0</a> |
| 2700K                  | VWFL (71°)       | 6700lm         | 67W                    | <a href="#">E21.618.001.0</a> |
| 3000K                  | NSP (15°)        | 6850lm         | 67W                    | <a href="#">E21.218.000.0</a> |
| 3000K                  | SP (21°)         | 6474lm         | 67W                    | <a href="#">E21.318.000.0</a> |
| 3000K                  | FL (38°)         | 6397lm         | 67W                    | <a href="#">E21.418.000.0</a> |
| 3000K                  | VWFL (71°)       | 7014lm         | 67W                    | <a href="#">E21.618.000.0</a> |
| 4000K                  | NSP (15°)        | 7021lm         | 67W                    | <a href="#">E21.228.000.0</a> |
| 4000K                  | SP (21°)         | 6626lm         | 67W                    | <a href="#">E21.328.000.0</a> |
| 4000K                  | FL (38°)         | 6547lm         | 67W                    | <a href="#">E21.428.000.0</a> |
| 4000K                  | VWFL (71°)       | 7178lm         | 67W                    | <a href="#">E21.628.000.0</a> |

\*Flux en sortie produit / Net luminaire output  
 \*\*Puissance max / Maximum power

| Dimensions câbles / Cable dimensions |                                |
|--------------------------------------|--------------------------------|
| Monochrome                           | 3 x 1 mm <sup>2</sup> - Ø8.9mm |

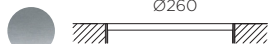
ALUMINIUM / Aluminium  BASSE PUISSANCE / Low Power

| T° couleur<br>Color T° | Optique<br>Optic | Flux*<br>Flux* | Puissance**<br>Power** | 230VAC                        |
|------------------------|------------------|----------------|------------------------|-------------------------------|
| 2700K                  | VNSP (7°)        | 2821lm         | 30W                    | <a href="#">E11.216.003.0</a> |
| 2700K                  | NSP (14°)        | 2611lm         | 30W                    | <a href="#">E11.216.002.0</a> |
| 2700K                  | FL (32°)         | 2551lm         | 30W                    | <a href="#">E11.416.001.0</a> |
| 2700K                  | VWFL (73°)       | 2731lm         | 30W                    | <a href="#">E11.616.001.0</a> |
| 3000K                  | VNSP (7°)        | 2950lm         | 30W                    | <a href="#">E11.216.000.0</a> |
| 3000K                  | NSP (14°)        | 2726lm         | 30W                    | <a href="#">E11.216.001.0</a> |
| 3000K                  | FL (32°)         | 2663lm         | 30W                    | <a href="#">E11.416.000.0</a> |
| 3000K                  | VWFL (73°)       | 2851lm         | 30W                    | <a href="#">E11.616.000.0</a> |
| 4000K                  | VNSP (7°)        | 3117lm         | 30W                    | <a href="#">E11.226.000.0</a> |
| 4000K                  | NSP (14°)        | 2885lm         | 30W                    | <a href="#">E11.226.001.0</a> |
| 4000K                  | FL (32°)         | 2819lm         | 30W                    | <a href="#">E11.426.000.0</a> |
| 4000K                  | VWFL (73°)       | 3018lm         | 30W                    | <a href="#">E11.626.000.0</a> |

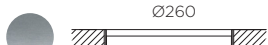
ALUMINIUM / Aluminium  HAUTE PUISSANCE / High power

| T° couleur<br>Color T° | Optique<br>Optic | Flux*<br>Flux* | Puissance**<br>Power** | 230VAC                        |
|------------------------|------------------|----------------|------------------------|-------------------------------|
| 2700K                  | NSP (15°)        | 6552lm         | 67W                    | <a href="#">E11.218.001.0</a> |
| 2700K                  | SP (21°)         | 6184lm         | 67W                    | <a href="#">E11.318.001.0</a> |
| 2700K                  | FL (38°)         | 6111lm         | 67W                    | <a href="#">E11.418.001.0</a> |
| 2700K                  | VWFL (71°)       | 6700lm         | 67W                    | <a href="#">E11.618.001.0</a> |
| 3000K                  | NSP (15°)        | 6850lm         | 67W                    | <a href="#">E11.218.000.0</a> |
| 3000K                  | SP (21°)         | 6474lm         | 67W                    | <a href="#">E11.318.000.0</a> |
| 3000K                  | FL (38°)         | 6397lm         | 67W                    | <a href="#">E11.418.000.0</a> |
| 3000K                  | VWFL (71°)       | 7014lm         | 67W                    | <a href="#">E11.618.000.0</a> |
| 4000K                  | NSP (15°)        | 7021lm         | 67W                    | <a href="#">E11.228.000.0</a> |
| 4000K                  | SP (21°)         | 6626lm         | 67W                    | <a href="#">E11.328.000.0</a> |
| 4000K                  | FL (38°)         | 6547lm         | 67W                    | <a href="#">E11.428.000.0</a> |
| 4000K                  | VWFL (71°)       | 7178lm         | 67W                    | <a href="#">E11.628.000.0</a> |

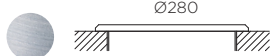
INOX 316L / Stainless steel  BASSE PUISSANCE / Low Power

| T° couleur<br>Color T° | Optique<br>Optic | Flux*<br>Flux* | Puissance**<br>Power** | 230VAC                        |
|------------------------|------------------|----------------|------------------------|-------------------------------|
| 2700K                  | VNSP (7°)        | 2821lm         | 30W                    | <a href="#">E22.216.003.0</a> |
| 2700K                  | NSP (14°)        | 2611lm         | 30W                    | <a href="#">E22.216.002.0</a> |
| 2700K                  | FL (32°)         | 2551lm         | 30W                    | <a href="#">E22.416.001.0</a> |
| 2700K                  | VWFL (73°)       | 2731lm         | 30W                    | <a href="#">E22.616.001.0</a> |
| 3000K                  | VNSP (7°)        | 2950lm         | 30W                    | <a href="#">E22.216.000.0</a> |
| 3000K                  | NSP (14°)        | 2726lm         | 30W                    | <a href="#">E22.216.001.0</a> |
| 3000K                  | FL (32°)         | 2663lm         | 30W                    | <a href="#">E22.416.000.0</a> |
| 3000K                  | VWFL (73°)       | 2851lm         | 30W                    | <a href="#">E22.616.000.0</a> |
| 4000K                  | VNSP (7°)        | 3117lm         | 30W                    | <a href="#">E22.226.000.0</a> |
| 4000K                  | NSP (14°)        | 2885lm         | 30W                    | <a href="#">E22.226.001.0</a> |
| 4000K                  | FL (32°)         | 2819lm         | 30W                    | <a href="#">E22.426.000.0</a> |
| 4000K                  | VWFL (73°)       | 3018lm         | 30W                    | <a href="#">E22.626.000.0</a> |

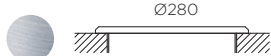
INOX 316L / Stainless steel  HAUTE PUISSANCE / High power

| T° couleur<br>Color T° | Optique<br>Optic | Flux*<br>Flux* | Puissance**<br>Power** | 230VAC                        |
|------------------------|------------------|----------------|------------------------|-------------------------------|
| 2700K                  | NSP (15°)        | 6552lm         | 67W                    | <a href="#">E22.218.001.0</a> |
| 2700K                  | SP (21°)         | 6184lm         | 67W                    | <a href="#">E22.318.001.0</a> |
| 2700K                  | FL (38°)         | 6111lm         | 67W                    | <a href="#">E22.418.001.0</a> |
| 2700K                  | VWFL (71°)       | 6700lm         | 67W                    | <a href="#">E22.618.001.0</a> |
| 3000K                  | NSP (15°)        | 6850lm         | 67W                    | <a href="#">E22.218.000.0</a> |
| 3000K                  | SP (21°)         | 6474lm         | 67W                    | <a href="#">E22.318.000.0</a> |
| 3000K                  | FL (38°)         | 6397lm         | 67W                    | <a href="#">E22.418.000.0</a> |
| 3000K                  | VWFL (71°)       | 7014lm         | 67W                    | <a href="#">E22.618.000.0</a> |
| 4000K                  | NSP (15°)        | 7021lm         | 67W                    | <a href="#">E22.228.000.0</a> |
| 4000K                  | SP (21°)         | 6626lm         | 67W                    | <a href="#">E22.328.000.0</a> |
| 4000K                  | FL (38°)         | 6547lm         | 67W                    | <a href="#">E22.428.000.0</a> |
| 4000K                  | VWFL (71°)       | 7178lm         | 67W                    | <a href="#">E22.628.000.0</a> |

| OPTIONS PRODUIT / Luminaire options      | Référence                                |
|--|--|
| T° couleur LED / LED colour temperature  | <a href="#">Sur demande / On request</a> |
| Câble supplémentaire / Additional cable  | <a href="#">T00.000.007.0</a>            |
| RAL spécial / Special RAL                | <a href="#">Sur demande / On request</a> |
| Connecteur IP68 / IP68 connector         | <a href="#">T00.000.078.0</a>            |
| Kit connexion IP68 / IP68 connection kit | <a href="#">T00.000.000.0</a>            |
| Filtre strié / Blade filter              | <a href="#">T00.000.091.0</a>            |
| Grille nid d'abeille / Honeycomb grid    | <a href="#">T00.000.061.0</a>            |
| Système antivol / Anti-theft system      | <a href="#">T00.000.056.0</a>            |

| Dimensions câbles / Cable dimensions |                    |
|--------------------------------------|--------------------|
| Monochrome                           | 3 x 1 mm2 - Ø8.9mm |